



Neon Line

Waterproof IP67



DecaLED® Neon Line Product specification

95197244	95197241	95197242	95197243
DecaLED® Neon Line, 1000mm, white	DecaLED® Neon Line, 1000mm, red	DecaLED® Neon Line, 1000mm, green	DecaLED® Neon Line, 1000mm, blue
See pricelist	See pricelist	See pricelist	See pricelist
95197245	95198244	95198241	95198242
DecaLED® Neon Line, 600mm, amber	DecaLED® Neon Line, 600mm, white	DecaLED® Neon Line, 600mm, red	DecaLED® Neon Line, 600mm, green
See pricelist	See pricelist	See pricelist	See pricelist
95198243	95198245	95199244	95199241
DecaLED® Neon Line, 600mm, blue	DecaLED® Neon Line, 400mm, white	DecaLED Neon Line, 400mm, red	DecaLED Neon Line, 400mm, green
See pricelist	See pricelist	See pricelist	See pricelist
95199242	95199243	95199245	
DecaLED Neon Line, 400mm, green	DecaLED Neon Line, 400mm, blue	DecaLED Neon Line, 400mm, amber	
See pricelist	See pricelist	See pricelist	

Accessories

Control	Control	Control	PSU
Controller 3 95350244 109	Controller 3 Mini 95350246 111	Controller 4 95350245 113	IP PSU 24VDC Various 121
See pricelist	See pricelist	See pricelist	See pricelist
Cabling	Cabling		
Starter cable, 1,5m 95749150	Link cable 1,5m 95749151		
See pricelist	See pricelist		

The DecaLED® Neon Line is an easy-to-install, professional LED alternative to traditional neon lighting. The DecaLED® Neon Line can be used for contour lighting, illuminated advertising and line lighting.

The DecaLED® Neon Line comes in three different lengths, namely a 400, 600 and 1000mm version. The DecaLED® Neon Line requires a 24VDC power supply and is fully sealed in a transparent, UV and IR-resistant housing. The DecaLED® Neon Line is impact-resistant, maintenance-free and waterproof (IP67), with an angle beam of 170° and a power consumption of 3.6, 5.4 or 9W p/s. The DecaLED® Neon Lines measure 23x26 (h x w). The DecaLED® Neon Lines can be linked together up to a maximum of 9 metres, depending on the power supply.

Various accessories are available for the DecaLED® Neon Line, including waterproof power supplies (page 125), brackets and end caps. The DecaLED® Dimmer for 12/24V is available for the single colour version. Further information on this product can be found on page 117.

The DecaLED® Neon Line is available in the colours red, green, blue and white. Another LED alternative to traditional neon lighting is the DecaLED® Neon Flex RGB. This can be found on page 61.

A demo set of this product is available. Please see page 124 of this catalogue.

Voltage	24VDC		
Current	0,2A	0,3A	0,4A
Power consumption	3,6W	5,4W	9W
Max. chainable	10m, depends on PSU		
Beam angle	170°		
Housing	UV and IR resistant		
Dimensions	23x26x400mm	23x26x600mm	23x26x1000mm
IP rating	IP67		

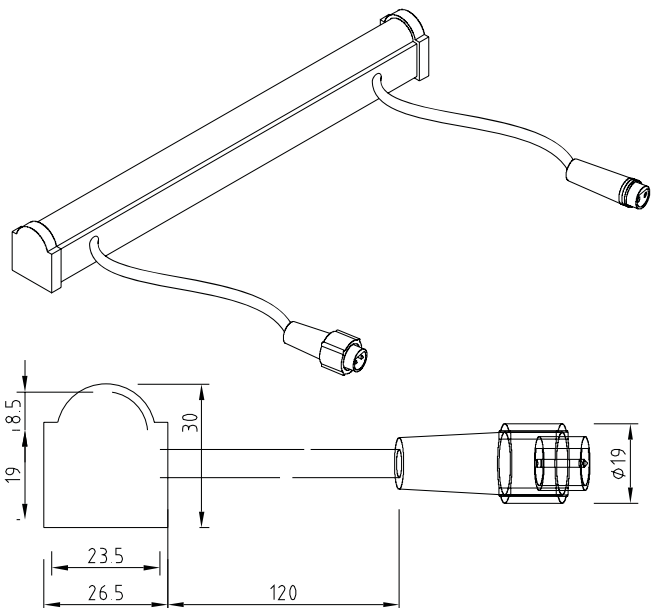

Waterproof IP67

Single colour

Demo set page 124

DecaLED® lighting products



IP PSU
30W

cable length
max 10m
(0.4mm²)*



DecaLED®
Neon Line

Max. to be connected
depends on PSU



IP PSU
60W

cable length
max 10m
(0.4mm²)*



DecaLED®
Neon Line

Max. to be connected
depends on PSU



IP PSU
150W

cable length
max 10m
(0.4mm²)*



DecaLED®
Neon Line

Max. to be connected
depends on PSU

* For installations that require longer cable lengths please contact your sales representative or calculate this using the product information



Visit www.lagotronics.com for additional information about this product.

Arton
Venlo, The Netherlands